

Birch Ply

Plywood for
transport industry

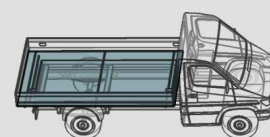

Metsä Wood plywood for the transport industry

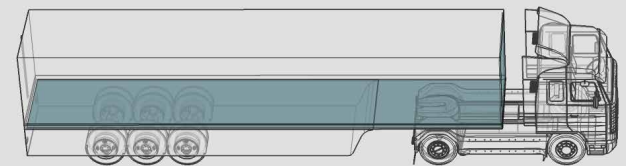
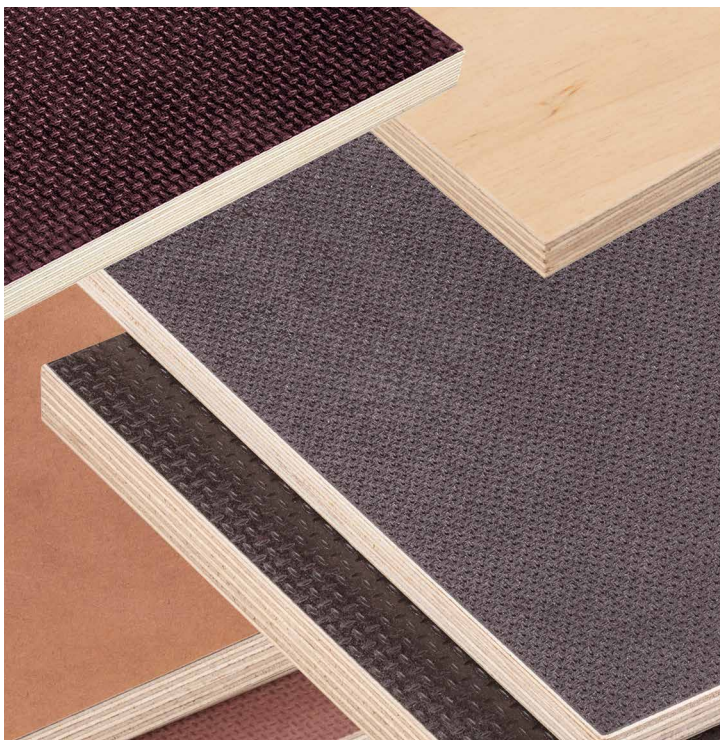
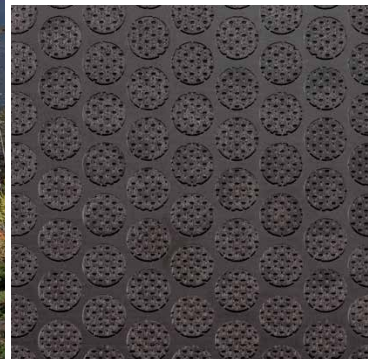







Metsä Wood's long traditions of plywood manufacturing and transport industry cooperation set high standards for plywood products and services. Metsä Wood is a proven and reliable partner for your business development needs.

Metsä Wood is proud to present a large portfolio of plywood products and services for wide range of end uses in the transport segment. The use of technically superior Northern wood material allows to optimise the use of wood to produce economical components with excellent strength properties. Metsä Wood plywood products fulfil the strictest quality requirements and are tested according to international standards.

The slip- and wear-resistant finishes meet the most demanding performance requirements. Wide range of panel sizes and development work with customers ensure material and economical efficiency.



METSÄ WOOD ADVANTAGES

-  Sustainable forestry
-  Renewable raw material
-  Cooperation values
-  Production technology
-  High-quality plywood products
-  R&D with new ideas
-  On-time deliveries
-  Sustainability
-  Continuous development

Industrial flexibility

Our plywood components are tailored to meet the needs of different uses of transportation industry.

Did you know?

that Finland's forests grow faster than they are harvested? The annual growth of trees totals 100 million cubic metres, while the amount of felled timber is only 60 million cubic metres.

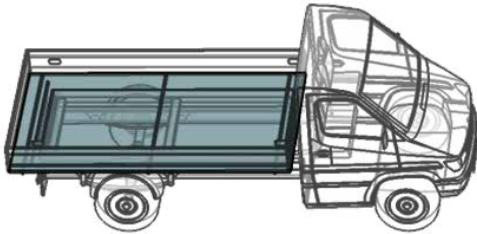

XL Size 6,000 x 2,200 mm

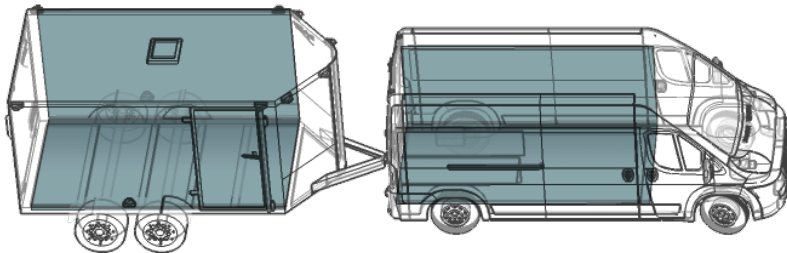

L Size 2,020 x 4,110 mm

L Size 1,800 x 3,000 mm

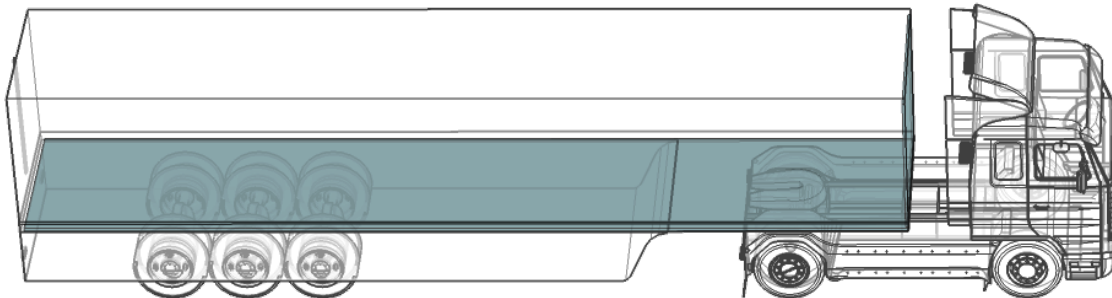

KingSize 13,500 x 2,500 mm

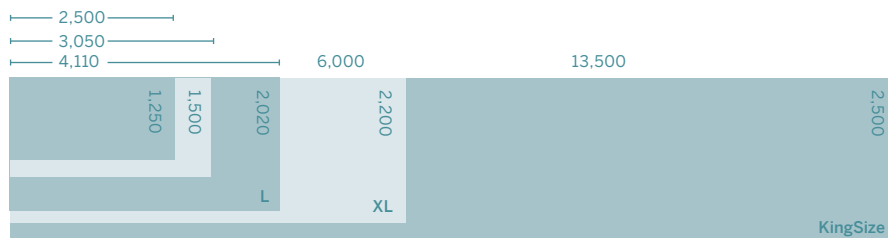

Did you know?

Metsä Wood sets new standard size 2,020 x 4,110 mm for seamless panels.

Heavy trailers

Metsä Wood plywood products and service offering allow customers to concentrate on their key strengths, while Metsä Wood takes care of correct and timely deliveries with high-quality products.

Metsä Wood has worked long in cooperation with major trailer manufacturers to meet and exceed the requirements of heavy transport applications. Metsä Wood plywood products for these applications are manufactured to withstand the daily grind of continual use. Large offering of panel sizes allow flexibility of design while not compromising material efficiency.

Metsä Wood plywood is exceptionally strong, light weight and easy to fix. Metsä Wood flooring products contribute to traffic safety by having exceptionally good friction values and thereby improving loading security.

Metsä Wood offers load bearing capacity components for floor applications and solutions for refrigerated trailers. Metsä Wood plywood products integrate into customers' process and as a new feature, Metsä Wood offers a glueable trailer floor panel.

Major advantages

- High strength-to-weight ratio
- On-time deliveries
- Variety of sizes
- Large 2,020 × 4,110 mm size seamless panels
- Maximal KingSize panel 13,500 × 2,500 mm

Metsä Wood plywood products for heavy trailers

- Deck, Deck L
- Floor, Floor L
- KingSize
- Birch, Birch L
- Integra, Integra L



Did you know?

Metsä Wood 30 mm plywood with 300 mm span can easily carry 7,800 kg forklift axle load.

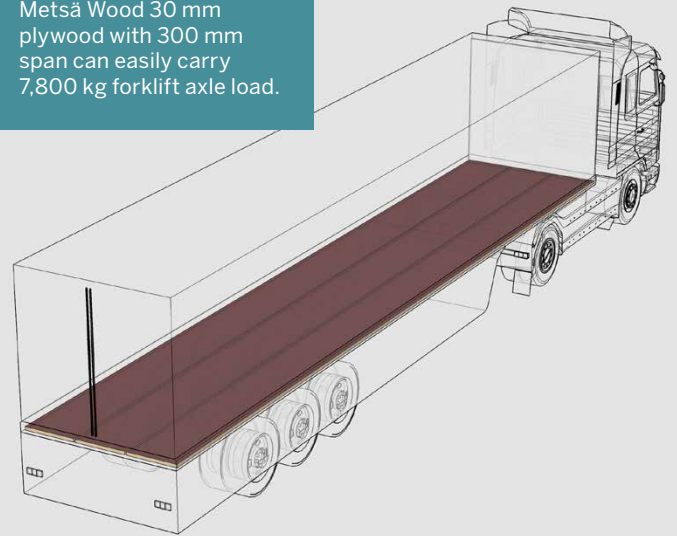

Delivery vans and light trailers

Metsä Wood birch plywood products have excellent strength-to-weight ratio. One piece panels offer platform for stiff and light structures. New seamless L sizes go up to 2,020 × 4,110 mm and larger XL panels with load bearing scarf joints up to 6,000 x 2,200 mm.

Metsä Wood plywood components are tailored according to customer specifications, with sizes varying from cut-to-size components to XL-size elements. The plywood components enable light-weight structures with a long life span and save time in the assembly phase.

Metsä Wood plywood products offer a choice of finishes from sanded wood surface to wide range overlay surfaces. The plywood components are easily maintained and have good fixing characteristics.

Major advantages

- Variety of surfaces and colours
- Excellent strength-to-weight ratio
- Seamless L sizes up to 2,020 x 4,110
- XL sizes up to 6,000 x 2,200
- Tailor-made components
- High visual quality
- Easy to clean surfaces

Metsä Wood plywood products for vans and light trailers

- Deck, Deck L
- Deck XL
- Flex, Flex L
- Flex XL
- Flex Smooth
- Floor, Floor L
- Granit, Granit L
- Top, Top L



Passenger transport

Passenger safety and comfort are first priority in bus and train industries. Metsä Wood plywood products offer solutions for these demanding end use applications.

Metsä Wood plywood products range from sound insulation and fire resistant solutions to specialised coatings. Products go through strict quality control during the manufacturing process. The high quality products for passenger transport fulfil the most common standards used in the bus and train industries. The continuous development work ensures that our customers are provided with the latest innovations.

Major advantages

- Many classifications available for passenger trains and busses
- High strength-to-weight ratio panel product with good sound reduction properties
- Dimensionally stable panels
- No endangered wood species
- No hazardous chemicals

Metsä Wood plywood products for passenger transport

- Sonex Light
- Integra, Integra L
- Birch, Birch L
- Deck, Deck L

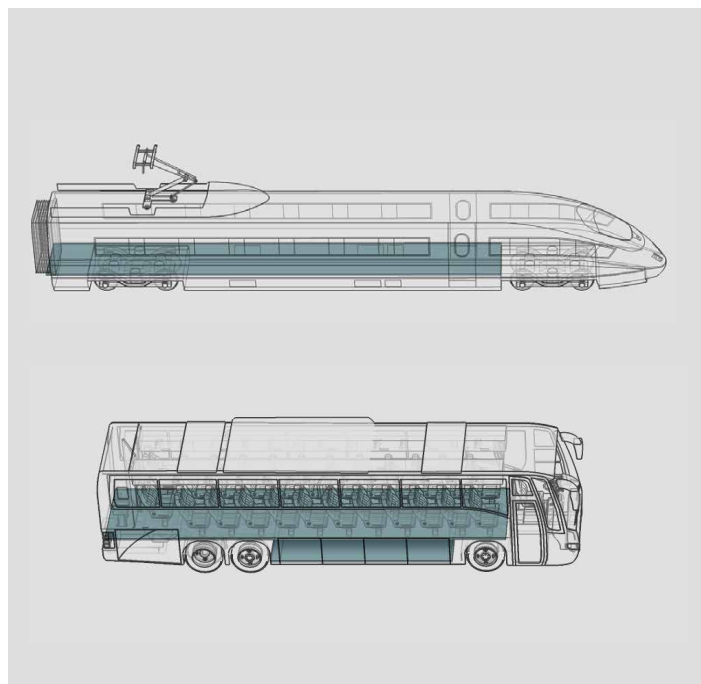

Did you know?

95% of Finnish commercial forests have been certified. Only 9% of all the forests in the world have been certified.

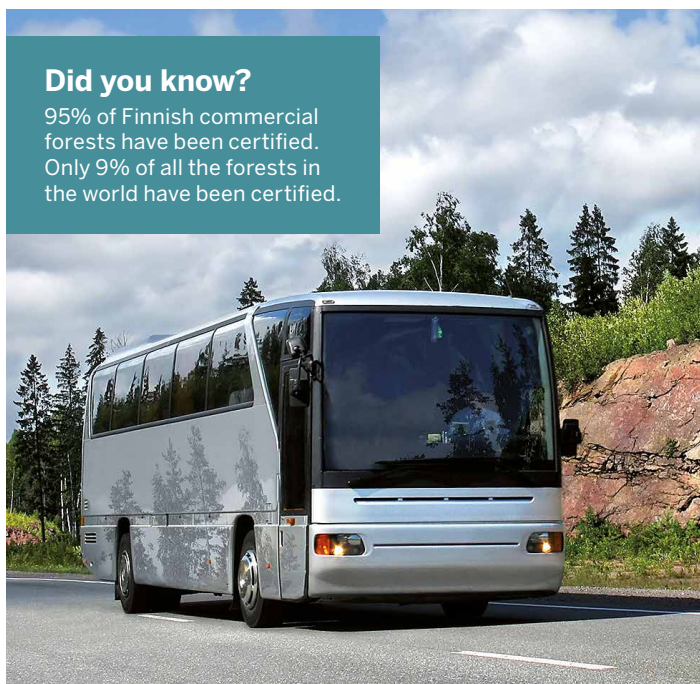

Special applications



Metsä Wood plywood special transport applications

- RoRo car decking
- Cassette systems
- Liquefied natural gas carriers (LNG)
- Transport platforms
- Cargohull flooring and lining for ships

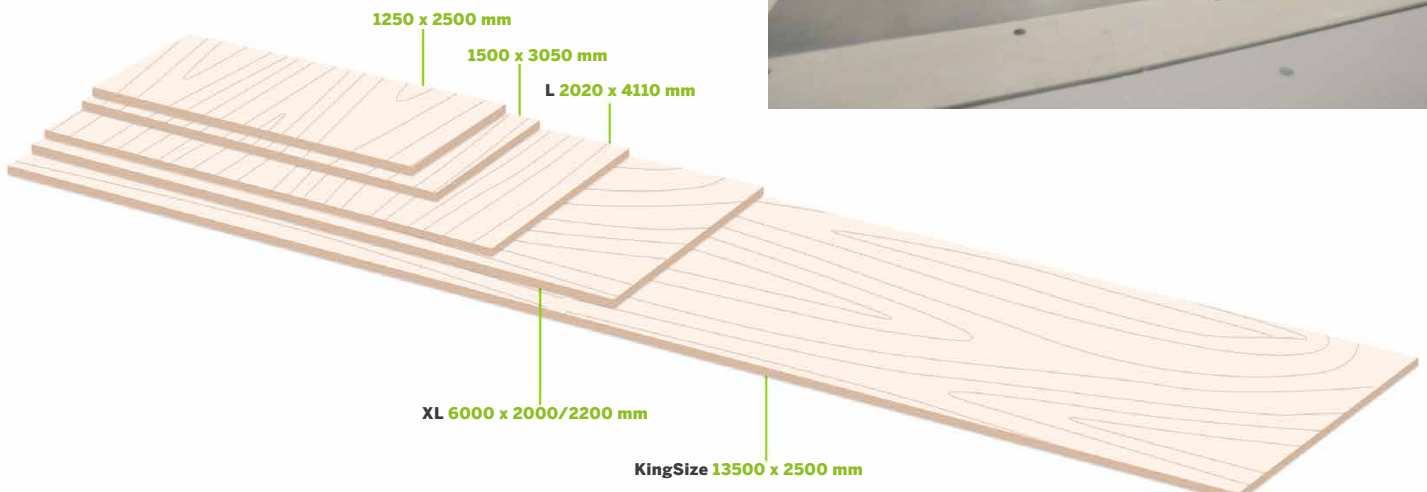
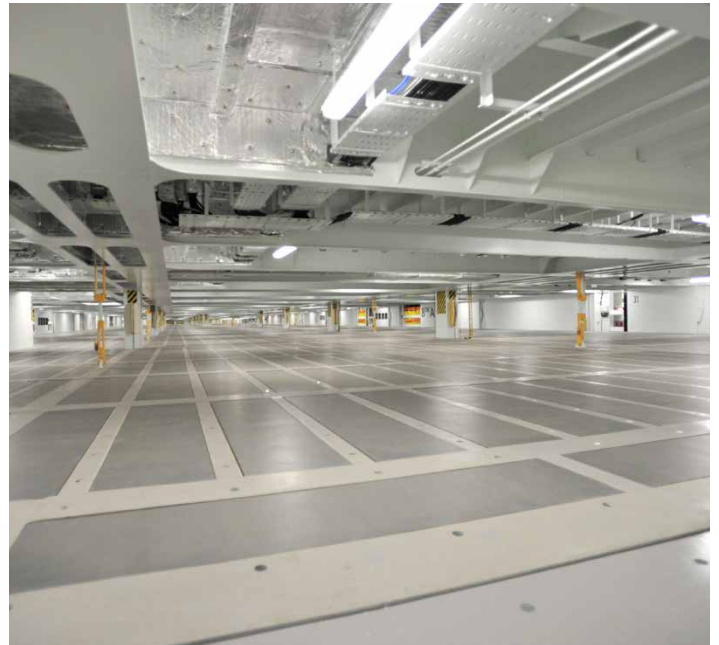

Floor products – resistance to abrasion, rolling and slipperiness

Rolling wear simulates the surface tolerance under a wheel load whereas the taber value indicates the surface tolerance against abrasion.

ABRASION, ROLLING WEAR AND SLIP RESISTANCE OF OVERLAID PLYWOOD PRODUCTS

PRODUCT	SURFACE	OVERLAY WEIGHT IF OPTIONAL	TABER REVOLUTIONS*	ROLLING WEAR**	SLIP RESISTANCE (FLOORING) ***
Deck (dark brown)	Wire mesh	120	350	3,500	R10
Deck (dark brown)	Wire mesh	220	700	5,000	R12
Top	Pattern	220	700	5,000	R10
Top	Pattern	440	2,100	7,000	R9
Floor 500	Wire mesh	-	3,200	7,000	R13
Granit Deck	Wire mesh	-	800	-	R10

* Abrasion resistance is tested according to DIN 53799/EN 438 until overlay is penetrated. The taber value is an approximate number of revolutions before the first signs of penetration occur.

** Resistance to rolling wear is determined by a method corresponding to SS 923508. Rolling wear is an average calculated from the random rolling movements with a load of 200 kg before the first signs of breakdown occur. The values are indicative and are valid for new unused panels.

*** Slip resistance is tested according to DIN 51130.

Wall products – trailer side walls, doors and bulk heads

Metsä Wood plywood products are available in a wide range of surface options. Birch plywood with excellent strength and stiffness properties combined with a high-quality surface is a good choice for demanding wall applications.

THICKNESS AND COLOURS OF OVERLAID WALL PRODUCTS

PRODUCT	OVERLAY MATERIAL	THICKNESS	COLOURS
Flex 0.2 mm	Thermoplastic	9–24 mm	White, Black
Flex 0.6 mm	Thermoplastic	12–24 mm	White, Grey
Flex smooth	Thermoplastic	11–17 mm	White

Trailer floor installation – fixings and sealing

Hot dip galvanized or stainless steel round head screws are most commonly used for plywood due to biocorrosion risk in humid conditions. Pilot drilling is always recommended when using screws, with the exception of self tapping screws. The dimensions of the fixings depend on the used plywood thickness.

Recommended spacing of screws:

- Along the edge of the panel 200-300 mm c/c
- In the middle of the panel 300-500 mm c/c
- Distance from edge min. 10 mm

A 1-2 mm gap must be left between the plywood panels to allow moisture movements. Gaps and fixing depressions should be filled with putty or paint. This enables the moisture movements of the panel and improves the edge protection.

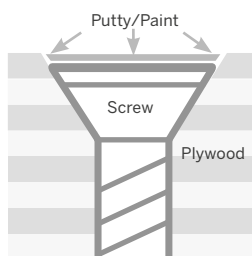

Trailer floor installation – Panels

Depending on the chassis design the panels can be installed longitudinally or transversally. Plywood panels must be supported on all four sides. By using oriented plywood constructions the thickness of the plywood panel can be reduced. With KingSize panels the floor can be made with only one piece. For more information on the panel installation, please visit www.metsawood.com.

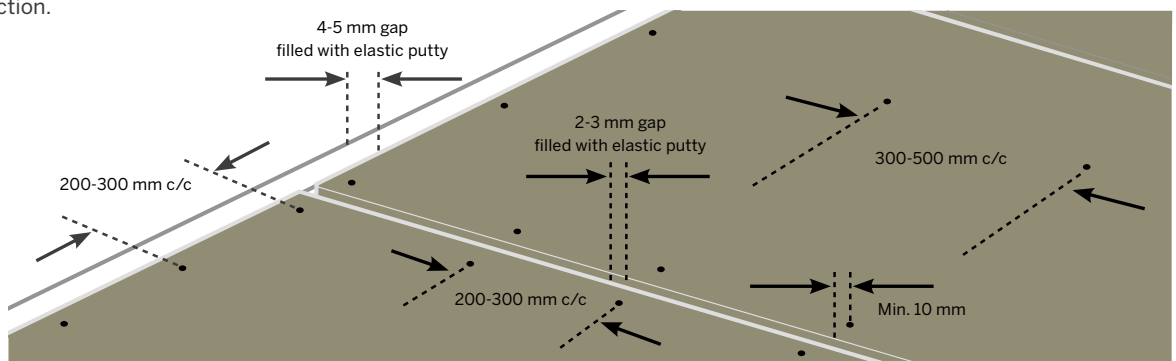

LOADING TABLE

Maximum wheel load F (kN/wheel) for birch plywood with oriented structure. Surface grain direction parallel to shorter edge of the panel. Strongest direction in direction of the longer panel dimension. Chassis construction: a rigid steel frame. Plate side ratio of 2.

THICKNESS (mm) / NUMBER OF PLYS

SPAN mm	15/11		18/13		21/15		21/16		24/17		24/18	
	F kN	u mm	F kN	u mm	F kN	u mm	F kN	u mm	F kN	u mm	F kN	u mm
300	10	5.9	14	4.9	19	4.2	22	3.9	24	3.6	27	3.4
400	9	9.7	12	8.0	16	6.8	19	6.4	21	5.9	23	5.6
500			11	11.7	15	10.0	17	9.3	19	8.6	21	8.2
600					14	13.6	15	12.7	17	11.8	20	11.2
800									16	19.2	18	18.2

SPAN mm	27/19		27/20		30/21		30/22		35/25		40/29	
	F kN	u mm	F kN	u mm	F kN	u mm	F kN	u mm	F kN	u mm	F kN	u mm
300	30	3.2	33	3.0	37	2.9	39	2.7	45	2.1	52	1.5
400	26	5.2	29	5.0	31	4.7	35	4.5	44	3.9	52	2.9
500	23	7.6	26	7.3	28	6.8	31	6.5	40	5.7	52	4.7
600	22	10.4	24	9.9	26	9.3	29	8.9	37	7.7	49	6.5
800	19	17	21	16.1	23	15.2	26	14.5	33	12.6	44	10.7

F = Maximum wheel load (kN)

u = approximate deflection (mm)

Moisture Content 15%. An increase in moisture strength will result in a decrease in strength, modulus of elasticity and shear modulus values.

Wheel contact area 80 mm x 180 mm.

Sonex sound insulation

	NOMINAL THICKNESS (mm)	SOUND REDUCTION INDEX * Rw (dB)	WEIGHT OF THE PANEL (kg/m ²)
SONEX LIGHT	One sound reduction layer		
	13	30	9.3
	16	31	10.9
	19	31	13.2

* The sound reduction index R was measured in accordance with EN ISO 10140-2:2010 and the weighted sound reduction index Rw was determined in accordance with EN ISO 717-1:1996. Special structures with higher sound insulation properties available on special request.

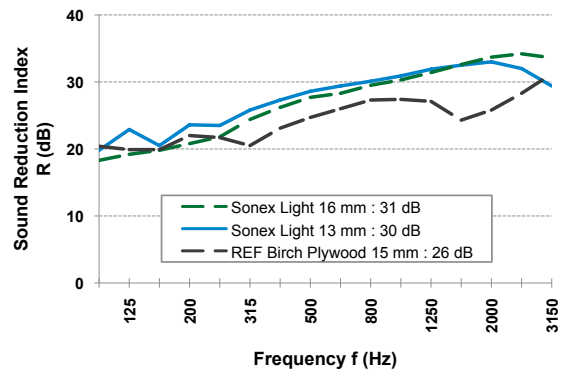

SONEX PRODUCT RANGE AND METSÄ WOOD BIRCH

- UN/ECE Regulation No. 118, (vertical and horizontal use)
- FMVSS 571.302

Sustainability



Metsä Wood is engaged in responsible operations and consider the economic, social and environmental impacts of our actions. Metsä Wood's environmental policy is based on the principles of environmental impact minimisation, continuous improvement, efficient use of raw materials and open communication. Certified environmental and quality systems support operational monitoring and systematic improvement in Metsä Wood's production units.

Sustainable use of wood

Metsä Wood's main raw material, wood, comes from sustainably managed northern forests where growth exceeds the use. All the used wood is 100% traceable and comes from certified or controlled forests. Metsä Group's wood tracing systems are certified and verified according to PEFC™ and FSC® Chain of Custody requirements. Most of the wood we use comes from forests owned by Metsä Group's 103 000 owner-members. Wood raw material is utilised to the fullest during the manufacture of different products. By-products – wood chips, sawdust and bark – are used as raw material for production plants or bioenergy production.

Management systems

Metsä Wood aims at continuous improvement of its operations. This is supported by management systems. Metsä Wood mills have certified management system including ISO 9001 quality management, ISO 14001 environmental management and ISO 45001 health and safety management.

Quality control

In addition to Metsä Wood's own quality control, Eurofins Expert Services Oy oversees production operations and the internal quality control at Metsä Wood plywood mills. External plywood quality control is conducted according to standard EN 13986 and its CE marking rules in cooperation with Eurofins.

Recycling and disposal

Disposal of Metsä Wood plywood products can be carried out by several methods. It should be noted that the instructions for disposal may vary in different countries depending on current legislation. Recycling of plywood by utilising it in other applications is always preferred, but Metsä Wood plywood products can be safely burnt when the combustion temperature is at least 850°C and correct combustion conditions are maintained. Metsä Wood plywood products contain nothing classified as hazardous waste.

Further information

- Metsä Wood product data sheets
- metsagroup.com/metsawood

Handling and storage of plywood panels

Plywood products, like any other wood-based panels, must be properly handled and stored. Otherwise panel surfaces, edges and corners may be damaged and the panels may twist and warp. Metsä Wood Plywood panels can be fastened, cut, shaped and drilled using correct woodworking fasteners and tools. Seal the resulting raw edges with water resistant paint. Panel surfaces can be repaired with water resistant fillers or patching materials.

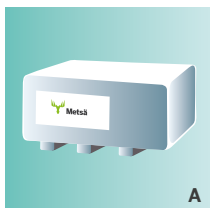

- It is recommended to keep plywood panels in their packaging during storage. This will protect the panels and help maintain the moisture content. Unopened packages can be temporarily stored outside due to the plastic wrapping. **(A)**



- Once the wrapping has been removed protect the panels from contact with water and direct sunlight by storing in a building or by covering with a suitable waterproof cover. Also avoid very dry and hot storage areas. **(B)**

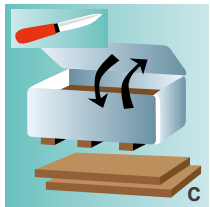

- Individual panels can be removed from the plastic wrapping. However, remember to close the package after opening. **(C)**

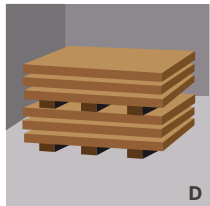

- Always store open packages in stable conditions (indoors). **(D)**



- It is recommended not to store packages in too high stacks, without storage shelves between packages to ensure safety and stability. Positioning of base under sticks shall be vertically in even line. Storage flooring should be horizontally even, level surface and a dry, covered area. **(E)**



- Loose panels should not be transported around the site using mechanical handling equipment, as panels are slippery. **(F)**



- At the end of their service life Metsä Wood plywood panels can be chipped and utilised in bio energy production. It should be noted that the instructions for disposal may vary in different countries depending on current legislation. **(G)**



- All Metsä Wood plywood packing material is recyclable. **(H)**

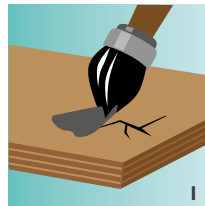

- Minor damage to the phenolic panels can be easily repaired by first sanding and then painting over the damaged area. **(I)**

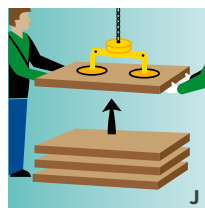

- Individual panels should always be moved by lifting and carrying them manually or automatically by vacuum lifting. They must not be pulled along the ground or the floor. **(J)**



- Plywood panels should always be stored horizontally. **(K)**



METSÄ WOOD
P.O. Box 50
02020 Metsä, Finland
Tel. +358 1046 05
metsagroup.com/metsawood

This leaflet is provided for information purposes only and no liability or responsibility of any kind is accepted by Metsä Wood or their representatives, although Metsä Wood has used reasonable efforts to verify the accuracy of any advice, recommendation or information. Metsä Wood reserves the right to alteration of its products, product information and product range without any notice.



Copyright © 04/2024 Metsä Wood. All rights reserved.